

1	CORPO	FERRO NODULAR ASTM A536 GR. 65.45.12
2	CASTELO	FERRO NODULAR ASTM A536 GR. 65.45.12
3	CUNHA DN. 1.½" a 3"	BRONZE ASTM B62 C83600
4	CUNHA DN. 4" a 24"	FERRO NODULAR com anéis em BRONZE
5	ANÉIS DE VEDAÇÃO	BRONZE ASTM B62 C83600
6	PREME GAXETA DN. 1.½" a 6"	AÇO CARBONO ASTM A216 GR.WCB
7	PREME GAXETA DN. 8" a 24"	FERRO NODULAR ASTM A536 GR. 65.45.12
8	HASTE	AÇO INOX AISI 410
9	CAIXA DA GAXETA DN. 1.½" a 6"	AÇO CARBONO ASTM A216 GR.WCB
10	CAIXA DA GAXETA DN. 8" a 24"	FERRO NODULAR ASTM A536 GR. 65.45.12
11	JUNTA	PAPELÃO HIDRÁULICA NA1100
12	GAXETA	TEFLON LUBRIFICADO
13	PARAFUSOS E PRISIONEIOS	A 307 - GR.A
14	PORCAS	A 563 - GR.A
	ANEL TRAVA DA HASTE	LATÃO LAMINADO ASTM B-16
	VOLANTE	FERRO NODULAR ASTM A536 GR. 65.45.12
	PORCA DA CUNHA	BRONZE ASTM B62 C83600

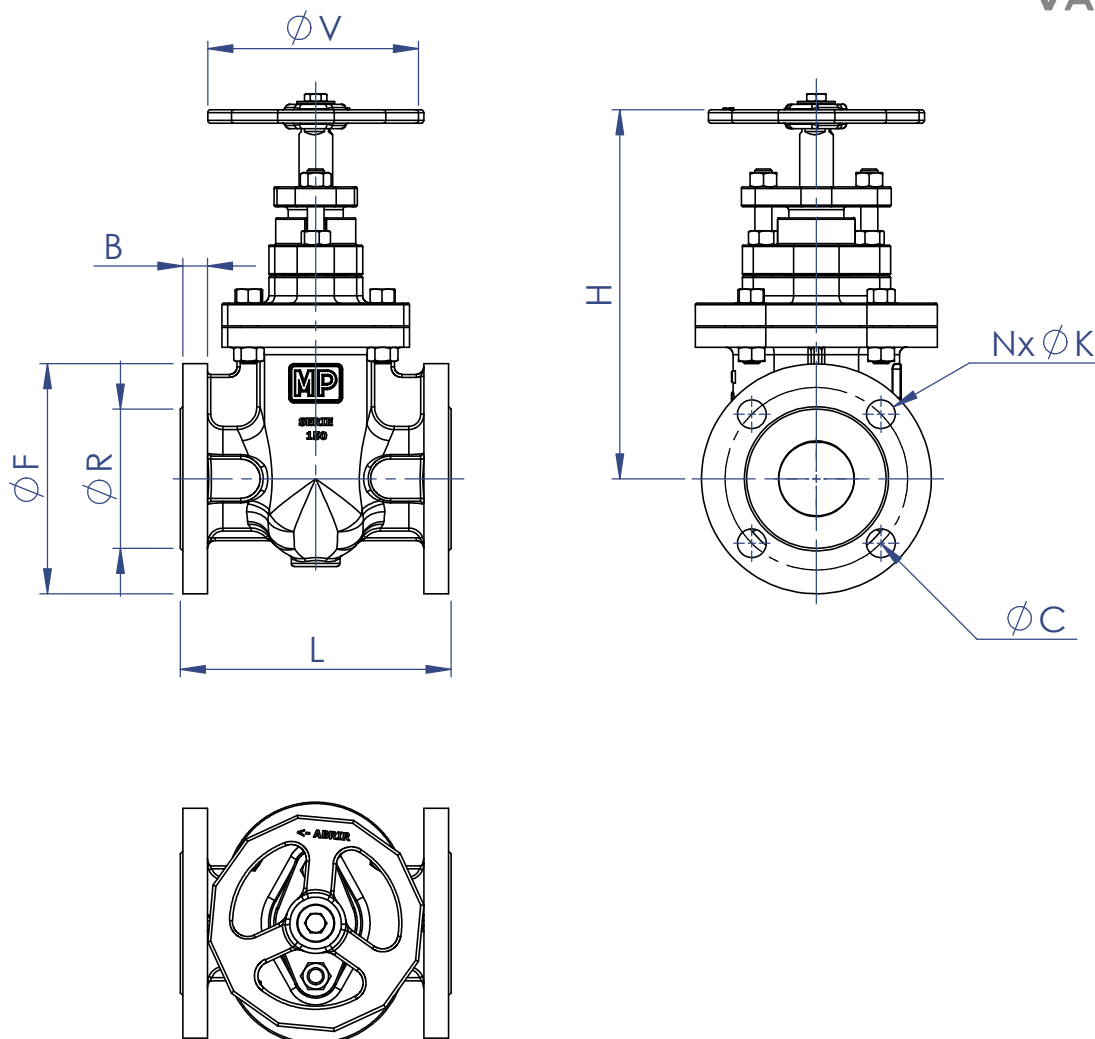

DN	L	F	R	B	C	N	K	H	V
1.½"	165	125	73	17,5	98,4	4	5/8"	240	150
2"	178	150	92	19,1	120,7	4	3/4"	270	200
2.½"	190	180	105	22,3	139,7	4	3/4"	300	200
3"	203	190	127	23,9	152,4	4	3/4"	310	200
4"	229	230	157	23,9	190,5	8	3/4"	355	250
5"	254	255	186	23,9	215,9	8	7/8"	395	250
6"	267	280	216	25,4	241,3	8	7/8"	490	300
8"	292	345	270	28,6	298,5	8	7/8"	570	350
10"	330	405	324	30,2	362,0	12	1"	635	420
12"	356	485	381	31,8	431,8	12	1"	765	420
14"	381	535	413	35,0	476,3	12	1.½"	845	500
16"	406	595	470	36,6	539,8	16	1.½"	920	500
18"	432	635	533	39,7	577,9	16	1.¼"	1200	600
20"	457	700	584	42,9	635,0	20	1.¼"	1300	600
24"	508	815	692	47,7	749,3	20	1.¾"	1530	800

