

OPÇÃO COM SISTEMA DE RETENÇÃO

1	CORPO	FERRO NODULAR ASTM A 536
2	CASTELO	FERRO NODULAR ASTM A 536
3	CONTRA SEDE DN. 1" a 3"	AÇO INOX ASTM A217 GR. CA15
	CONTRA SEDE DN. 4" a 12"	FERRO NODULAR com anel em CA15
4	ANEL DE VEDAÇÃO	AÇO INOX ASTM A217 GR. CA15
5	JUNTA	PAPELÃO HIDRÁULICO NA1040
6	GAXETA	TEFLON LUBRIFICADO
7	PARAFUSOS	A 307 GR. A
8	PORCAS	A 563
9	HASTE	AÇO INOX AISI 410
10	PREME GAXETA DN. 1" a 6"	AÇO CARBONO ASTM A 216 GR. WCB
	PREME GAXETA DN. 8" a 12"	FERRO NODULAR ASTM A 536
11	VOLANTE	FERRO NODULAR ASTM A 536
12	PORCA CONTRA SEDE	AÇO INOX AISI 410
13	PINO GUIA	AÇO INOX AISI 410

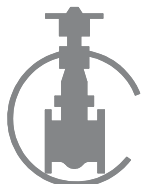

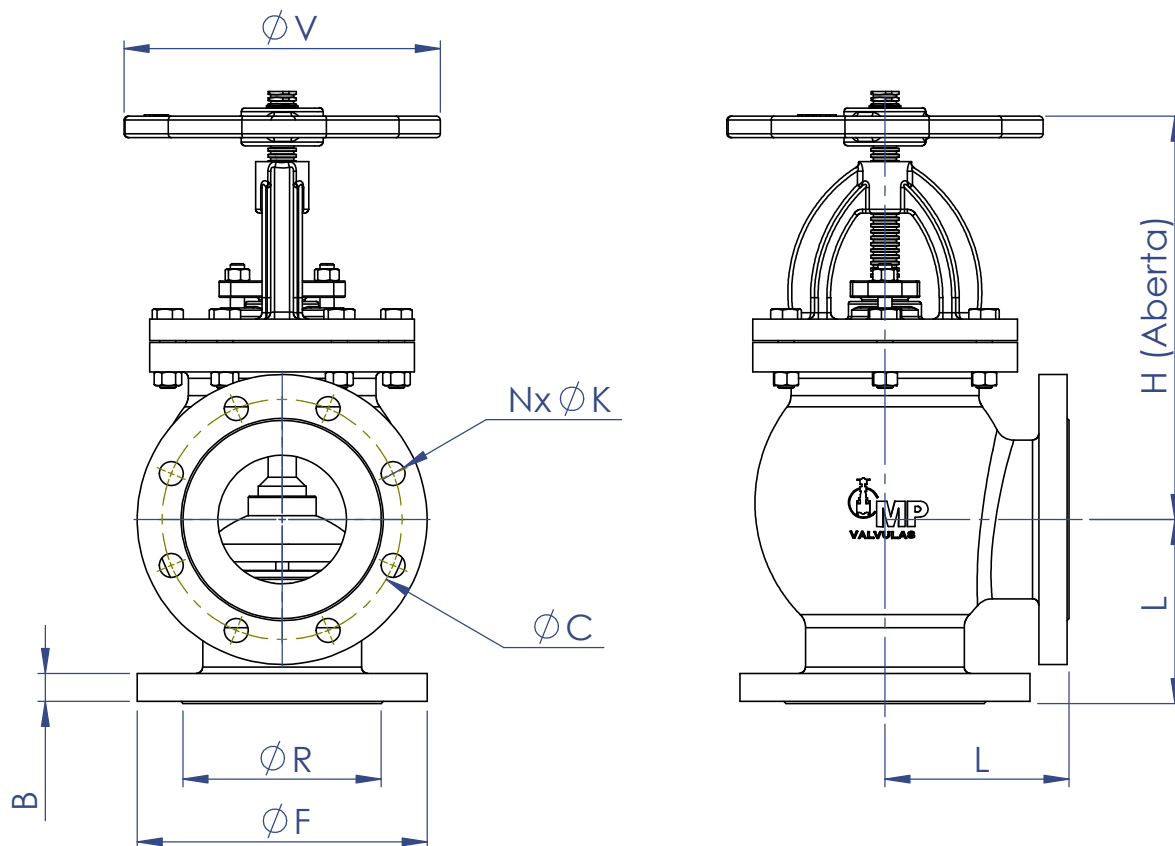

DN		L	F	R	B	C	N	K	V	H
inch.	mm									
1"	25	65	110	50,8	14,2	79,4	4	5/8"	150	182
1.½"	40	83	125	73	14,2	98,4	4	5/8"	150	265
2"	50	102	150	92,1	15,8	120,7	4	3/4"	200	340
2.½"	65	108	180	104,8	17,5	139,7	4	3/4"	200	345
3"	75	121	190	127	19,1	152,4	4	3/4"	200	350
4"	100	146	230	157,2	23,9	190,5	8	3/4"	250	385
5"	125	165	255	185,7	23,9	215,9	8	7/8"	300	500
6"	150	178	280	215,9	25,4	241,3	8	7/8"	350	545
8"	200	248	345	269,9	28,4	298,5	8	7/8"	420	580
10"	250	310	405	323,8	30,2	362	12	1"	500	635
12"	300	350	485	381	31,8	431,8	12	1"	500	895

