

OPÇÃO COM
SISTEMA DE
RETENÇÃO

1	CORPO	BRONZE ASTM B62 C83600
2	CASTELO	BRONZE ASTM B62 C83600
3	CONTRA SEDE	BRONZE ASTM B62 C83600
4	ANEL DE VEDAÇÃO	BRONZE ASTM B62 C83600
5	JUNTA	PAPELÃO HIDRÁULICO NA1040
6	GAXETA	TEFLON LUBRIFICADO
7	PARAFUSOS	A 307 GR. A
8	PORCAS	A 563
9	HASTE	LATÃO LAMINADO ASTM B16
10	PREME GAXETA	BRONZE ASTM B62 C83600
11	VOLANTE	FERRO NODULAR ASTM A 536
12	PORCA CONTRA SEDE	LATÃO LAMINADO ASTM B16
13	PINO GUIA	LATÃO LAMINADO ASTM B16

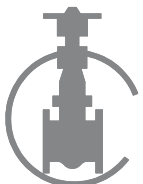

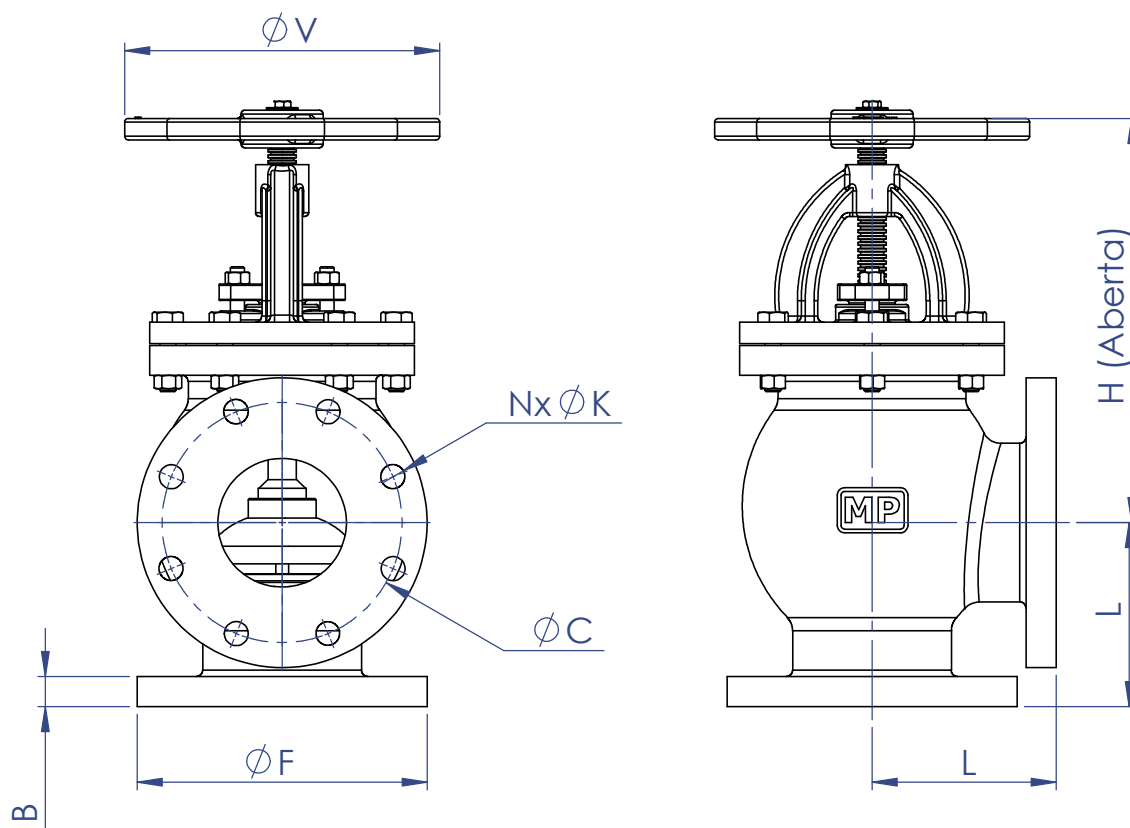

DN		L	F	B	C	N	K	V	H
inch.	mm								
1"	25	65	110	14,2	79,4	4	5/8"	150	182
1½"	40	83	125	14,2	98,4	4	5/8"	150	265
2"	50	102	150	15,8	120,7	4	3/4"	200	340
2½"	65	108	180	17,5	139,7	4	3/4"	200	345
3"	75	121	190	19,1	152,4	4	3/4"	200	350
4"	100	146	230	23,9	190,5	8	3/4"	250	385
5"	125	165	255	23,9	215,9	8	7/8"	300	500
6"	150	178	280	25,4	241,3	8	7/8"	350	545
8"	200	248	345	28,4	298,5	8	7/8"	420	580
10"	250	310	405	30,2	362	12	1"	500	635
12"	300	350	485	31,8	431,8	12	1"	500	895

