

1	CORPO
2	CASTELO
3	CUNHA
4	ANEL DE VEDAÇÃO
5	HASTE
6	JUNTA
7	GAXETA
8	PARAFUSOS E ESTOJOS
9	PORCAS
10	CAIXA
11	TAMBOR DE ACIONAMENTO
12	PREME GAXETA
13	VOLANTE
14	PORCA DO VOLANTE

AÇO CARBONO ASTM A 216 GR. WCB
AÇO CARBONO ASTM A 216 GR. WCB
AÇO INOX ASTM A217 GR. CA15
AÇO INOX ASTM A217 GR. CA15
AÇO INOX AISI 410
PAPELÃO HIDRÁULICO NA1100
TEFLON LUBRIFICADO
A 193 - GR.B7 ou A 325
A 194 - GR.2H
AÇO CARBONO ASTM A 216 GR. WCB
BRONZE INDUSTRIAL ASTM B-62
AÇO CARBONO ASTM A 216 GR. WCB
FERRO NODULAR ASTM A 536
FERRO NODULAR ASTM A 536

NORMAS APLICADAS

NBR 15827
ISO 10434
ISO 5208
API 600
ASME B16.10
ASME B16.34
ASME B16.5
MSS SP 6

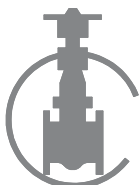

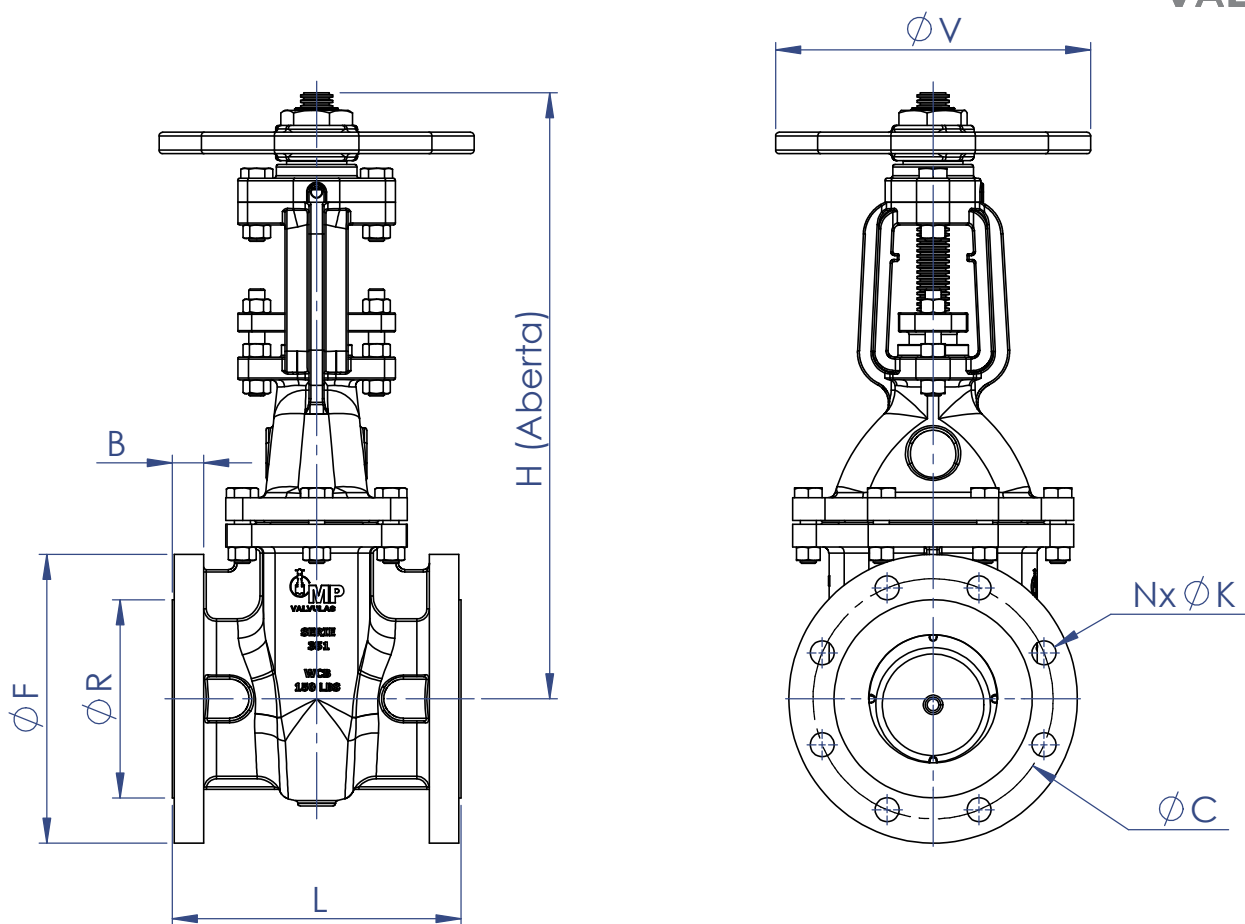

DN	L	F	R	B	C	N	K	H	V
1½"	165	125	73,0	17,5	98,4	4	5/8"	340	150
2"	178	150	92,1	19,1	120,7	4	3/4"	390	200
2½"	190	180	104,8	22,3	139,7	4	3/4"	460	200
3"	203	190	127,0	23,9	152,4	4	3/4"	470	200
4"	229	230	157,2	23,9	190,5	8	3/4"	600	300
5"	254	255	185,7	23,9	215,9	8	7/8"	700	300
6"	267	280	215,9	25,4	241,3	8	7/8"	800	350
8"	292	345	269,9	28,6	298,5	8	7/8"	985	420
10"	330	405	323,8	30,2	362,0	12	1"	1225	420
12"	356	485	381,0	31,8	431,8	12	1"	1410	550
14"	381	535	412,8	35,0	476,3	12	1.½"	1660	550
16"	406	595	469,9	36,6	539,8	16	1.½"	1755	550
18"	432	635	533,4	39,7	577,9	16	1.¼"	1955	600
20"	457	700	584,2	42,9	635,0	20	1.¼"	2130	600
24"	508	815	692,2	47,7	749,3	20	1.¾"	2560	800

