

1	CORPO	AÇO CARBONO ASTM A 216 GR. WCB
2	CASTELO	AÇO CARBONO ASTM A 216 GR. WCB
3	CUNHA	AÇO INOX ASTM A217 GR. CA15
4	ANÉIS DE VEDAÇÃO DO CORPO	AÇO INOX ASTM A217 GR. CA15
5	PREME GAXETA	AÇO CARBONO ASTM A 216 GR. WCB
6	HASTE	AÇO INOX AISI 410
7	CAIXA DO TAMBOR	AÇO CARBONO ASTM A 216 GR. WCB
8	JUNTA	PAPELÃO HIDRÁULICO NA1100
9	GAXETA	TEFLON LUBRIFICADO
10	TAMBOR DE ACIONAMENTO	BRONZE INDUSTRIAL ASTM B-62
11	PARAFUSOS E PRISIONEIRO	A 193 - GR.B7
12	PORCAS	A 194 - GR.2H
13	VOLANTE DE ACIONAMENTO	FERRO NODULAR ASTM A 536 GR.65.45.12
14	PORCA DO VOLANTE	FERRO NODULAR ASTM A 536 GR.65.45.12

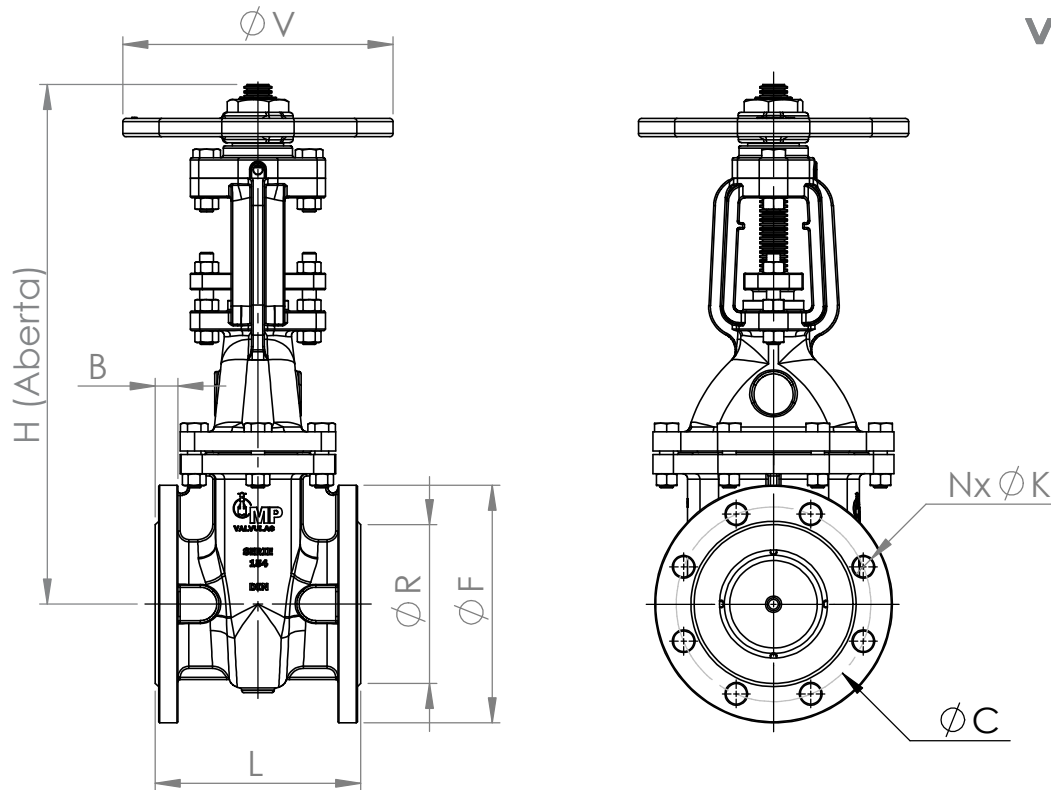

	DN	L	F	R	B	C	N	K	H	V
PN 16	40	140	150	88	19	110	4	19	300	150
	50	150	165	99	19	125	4	19	335	200
	65	170	185	122	19	145	4	19	375	200
	75	180	194	127	19	154	4	19	385	200
	80	180	200	132	19	160	8	19	385	200
	100	190	220	156	19	180	8	19	475	300
	125	200	250	188	19	210	8	19	535	300
	150	210	285	211	19	240	8	23	600	350
PN 10	200	230	340	266	20	295	12	23	765	420
	250	250	400	319	22	350	12	23	960	420
	300	270	455	370	24,5	400	12	23	1070	550
PN 6	350	290	505	429	24,5	460	16	23	1120	550
	400	310	565	480	24,5	515	16	28	1370	550
	450	330	615	530	25,5	565	20	28	1470	600
	500	350	670	582	26,5	620	20	28	1600	600
4	600	390	780	682	30	725	20	31	1940	800

CLASSE DE PRESSÕES

DN. 40 a 200	PN 16
DN. 250 a 300	PN 10
DN. 350 a 500	PN 6
DN. 600	PN 4

NORMAS APLICADAS

NBR 12430
NBR 7675
ISO 2531
NBR 6916

