

1	CORPO
2	CASTELO
3	CUNHA
4	ANÉIS DE VEDAÇÃO
5	PREME GAXETA
6	HASTE
7	CAIXA DA GAXETA
8	JUNTA
9	GAXETA
10	PARAFUSOS E PRISIONEIROS
11	PORCAS
12	ANEL TRAVA DA HASTE
13	VOLANTE

AÇO INOX ASTM A 351 GR. CF8M
AÇO INOX ASTM A 351 GR. CF8M
AÇO INOX ASTM A 351 GR. CF8M
AÇO INOX ASTM A 351 GR. CF8M
AÇO INOX ASTM A 351 GR. CF8M
AÇO INOX AISI 316
AÇO INOX ASTM A 351 GR. CF8M
PAPELÃO HIDRÁULICA NA1100
TEFLON LUBRIFICADO
A 193 GR.B8M
A 194 GR.8M
LATÃO LAMINADO ASTM B-16
FERRO NODULAR ASTM A536 GR. 65.45.12

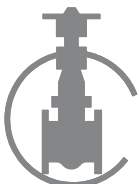

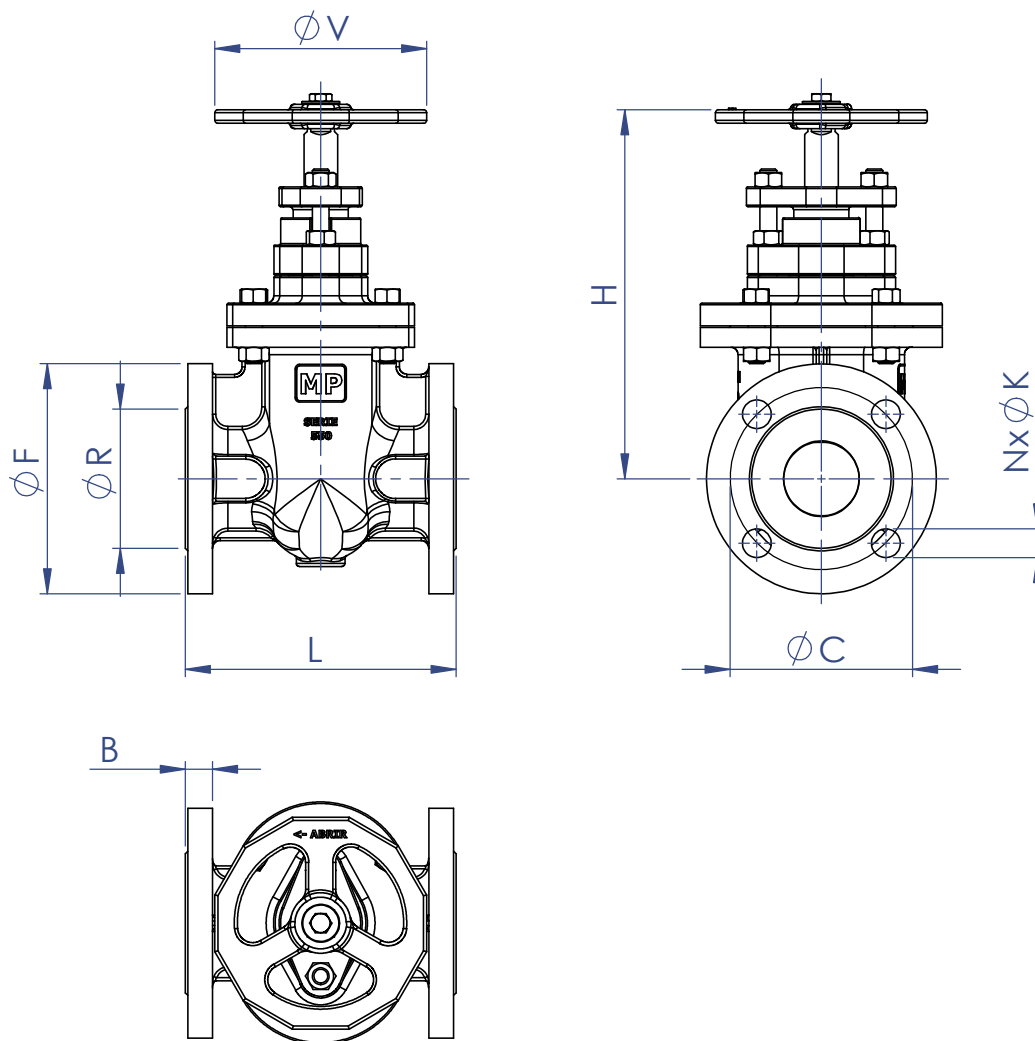

DN	L	F	R	B	C	N	K	H	V
1.½"	165	125	73	17,5	98,4	4	5/8"	240	150
2"	178	150	92	19,1	120,7	4	3/4"	270	200
2.½"	190	180	105	22,3	139,7	4	3/4"	300	200
3"	203	190	127	23,9	152,4	4	3/4"	310	200
4"	229	230	157	23,9	190,5	8	3/4"	355	250
5"	254	255	186	23,9	215,9	8	7/8"	395	250
6"	267	280	216	25,4	241,3	8	7/8"	490	300
8"	292	345	270	28,6	298,5	8	7/8"	570	350
10"	330	405	324	30,2	362,0	12	1"	635	420
12"	356	485	381	31,8	431,8	12	1"	765	420
14"	381	535	413	35,0	476,3	12	1.½"	845	500
16"	406	595	470	36,6	539,8	16	1.½"	920	500
18"	432	635	533	39,7	577,9	16	1.¼"	1200	600
20"	457	700	584	42,9	635,0	20	1.¼"	1300	600
24"	508	815	692	47,7	749,3	20	1.¾"	1530	800

