

1	CORPO
2	CASTELO
3	CONTRA SEDE
4	ANEL DE VEDAÇÃO DO CORPO
5	ANEL DE VEDAÇÃO DA CONTRA SEDE
6	PORCA DA HASTE
7	HASTE
8	PARAFUSOS
9	ANEL O´RING DE VEDAÇÃO
10	GAXETA
11	PORCA PREME
12	PREME GAXETA
13	VOLANTE

BRONZE INDUSTRIAL ASTM B-62
BRONZE INDUSTRIAL ASTM B-62
LATÃO LAMINADO ASTM B-16 CLA 360
AÇO INOX ASTM A217 GR. CA15
BORRACHA NEOPRENE
LATÃO LAMINADO ASTM B-16 CLA 360
LATÃO LAMINADO ASTM B-16 CLA 360
AÇO INOX AISI 304
BORRACHA BUNA-N
TEFLON LUBRIFICADO
LATÃO LAMINADO ASTM B-16 CLA 360
LATÃO LAMINADO ASTM B-16 CLA 360
FERRO NODULAR ASTM A 536 GR. 65.45.12

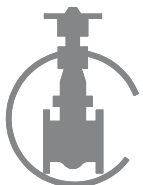

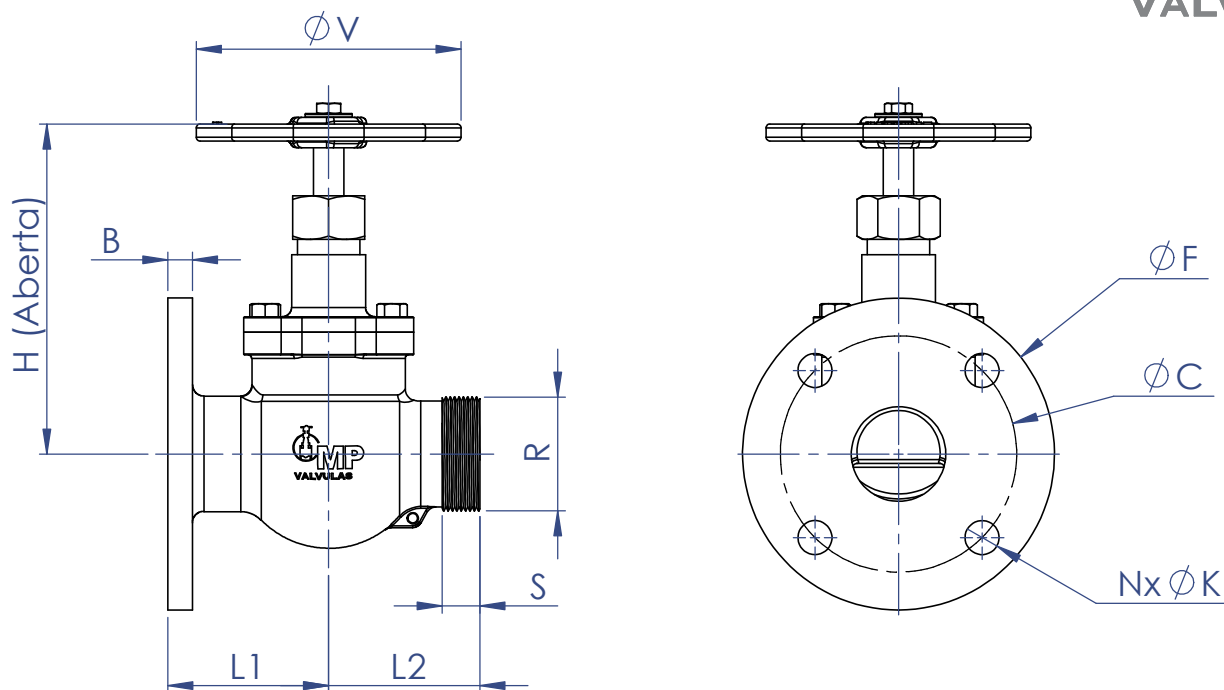

DN		L1	L2	F	C	N	K	B	H	V	R	S
inch.	mm											
1.½"	40	75	63	150	110	4	19	12	165	150	Ø47 11FPP BSP	17
2"	50	85	80	165	125	4	19	13	205	150	Ø59,5 11FPP BSP	20
2.½"	65	85	85	185	145	4	19	14	205	150	Ø77 7,5FPP NPT	25

